

## Wireless Light Meter

### General Description

The Wireless Light Meter measures the intensity of light from 0–82,000 lux (luminescence/unit area).

- Measures the amount of light present
- Can alert upon immediate detection of light or a change in light intensity
- Highly sensitive photodiode

### Principle of Operation

The Wireless Light Meter uses a highly sensitive photo-diode to detect and measure the intensity of light around the device. The sensor is also capable of alerting upon detection of a change in lighting conditions. The sensor returns a value in “lux” to the ICARE Online Sensor Monitoring and Notification System. The data is stored in the online system and can be reviewed and exported as a data sheet or graph. Notifications can be set up through the online system to alert the user when light is present or not with the ability to only notify within time of day parameters. Perfect for light sensitive applications like museum and art gallery light monitoring

### Example Applications

- Art gallery light metering
- Museum light metering
- Greenhouse and agricultural light monitoring
- Facilities lighting/energy management
- Business light monitoring
- Home light monitoring
- Many additional applications

### Features of ICARE Sensors

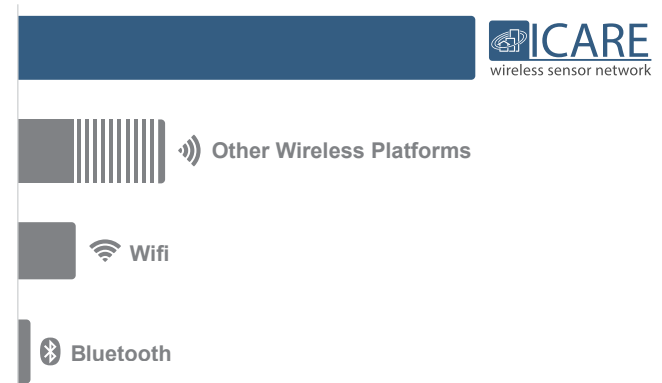

- Wireless range of 1,200+ feet through 12+ walls \*
  - Frequency-Hopping Spread Spectrum (FHSS)
  - Improved interference immunity
  - Improved power management for longer battery life \*\* (12+ years on AA batteries)
  - Security (Diffie-Hellman Key Exchange + AES-128 CBC for sensor data messages)
  - Onboard data memory stores up to 3200 readings per sensor:
    - 10-minute heartbeats = 22 days
    - 2-hour heartbeats = 266 days
  - Over-the-air updates (future proof)
  - Online wireless sensor monitoring and notification system to configure sensors, view data and set alerts via SMS text and email
- \* Actual range may vary depending on environment.  
 \*\* Battery life is determined by sensor reporting frequency and other variables. Other power options are also available.

### Wireless Range Comparison

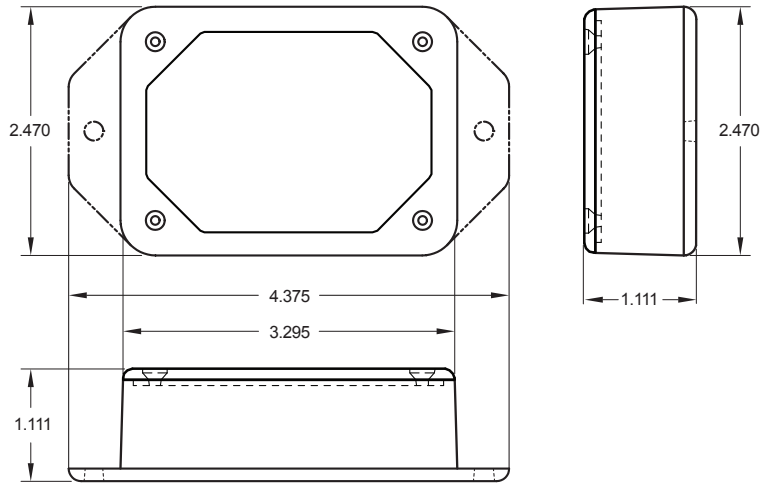



## Commercial AA Wireless Light Meter | Technical Specifications

Supply voltage	2.0–3.6 VDC (3.0–3.6 VDC using power supply) *
Current consumption	0.2 $\mu$ A (sleep mode), 0.7 $\mu$ A (RTC sleep), 570 $\mu$ A (MCU idle), 2.5 mA (MCU active), 5.5 mA (radio RX mode), 22.6 mA (radio TX mode)
Operating temperature range (board circuitry and batteries)	-18°C to 55°C (0°F to 130°F) using alkaline -40°C to 85°C (-40°F to 185°F) using lithium **
Optimal battery temperature range (AA)	+10°C to +50°C (+50°F to +122°F)
Max Light Level	0–82,000 Lux
Integrated memory	Up to 3200 sensor messages
Wireless range	1,200+ ft non-line-of-sight
Security	256-bit key exchange and AES-128 CTR
Weight	3.7 ounces
Certifications	<div style="display: flex; align-items: center; gap: 10px;">   <span>Industry Canada</span> </div> 900 MHz wireless product; FCC ID: ZTL-G2SC1 and IC: 9794A-G2SC1.

\* Hardware cannot withstand negative voltage. Please take care when connecting a power device.

\*\* At temperatures above 100°C, it is possible for the board circuitry to lose programmed memory.

## Power Options

The standard version of this sensor is powered by two replaceable 1.5 V AA sized batteries (included with purchase).

This sensor is also available with a line power option. The line powered version of this sensor has a barrel power connector allowing it to be powered by a standard 3.0–3.6 V power supply. The line powered version also uses two standard 1.5 V AA batteries as backup for uninterrupted operation in the event of line power outage.

Power options must be selected at time of purchase, as the internal hardware of the sensor must be changed to support the selected power requirements.

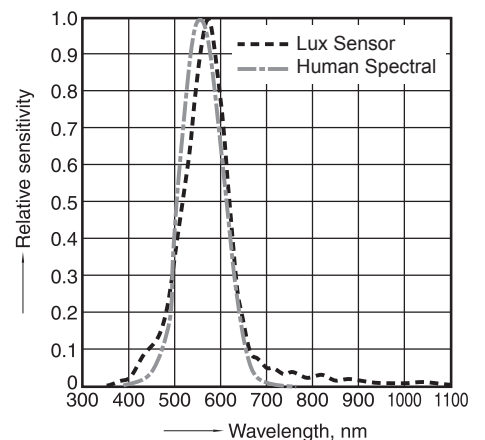

## Relative sensitivity vs. wavelength

Ambient Temperature: 25°C (77°F)

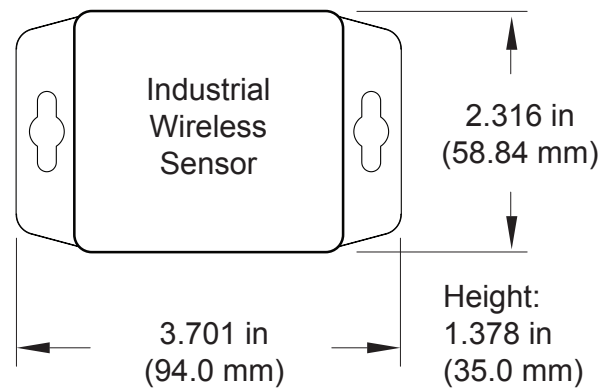



## Industrial Wireless Light Meter | Technical Specifications

Supply voltage	2.0–3.6 VDC (3.0–3.6 VDC using power supply) *	
Current consumption	0.2 $\mu$ A (sleep mode), 0.7 $\mu$ A (RTC sleep), 570 $\mu$ A (MCU idle), 2.5 mA (MCU active), 5.5 mA (radio RX mode), 22.6 mA (radio TX mode)	
Operating temperature range (board circuitry and battery)	-40°C to +80°C (-40°F to +176°F) **	
Included battery	Max temperature range	-40° to +80°C (-40° to +176°F)
	Capacity	1500 mAh
Optional solar feature	Solar panel	5VDC/30mA (53mm x 30mm)
	Charging temperature range	0° to 45°C (32° to 113°F)
	Max temperature range	-20° to 60°C (-4° to 140°F)
	Included rechargeable battery	600 mAh/>2000 charge cycles (80% of initial capacity)
	Solar efficiency	Optimized for high and low-light operation ***
	Charging efficiency	40% ***
	Luminous sustainability	Minimum of 250 LUX ***
Max Light Level	0–82,000 Lux	
Integrated memory	Up to 3200 sensor messages	
Wireless range	1,200+ ft non-line-of-sight	
Security	256-bit key exchange and AES-128 CTR	
Weight	4.7 ounces	
Enclosure rating	NEMA 1, 2, 4, 4x, 12 and 13 rated, sealed and weather proof	
UL rating	UL Listed to UL508-4x specifications (File E194432)	
Certifications	 	900 MHz wireless product; FCC ID: ZTL-G2SC1 and IC: 9794A-G2SC1.

\* Circuits cannot withstand negative voltage. Please take care when installing batteries.

\*\* At temperatures above 100°C, it is possible for the board circuitry to lose programmed memory.

\*\*\* Solar feature's energy harvesting circuitry works indoors with low light. Light present 25% of day yields 125% of operating power to support 10-minute heartbeats.

## Commercial Grade Sensors

ICARE commercial grade sensors are designed for applications in ordinary environments (normal room temperature, humidity and atmospheric pressure). Do not use these sensors under the following conditions as these factors can deteriorate the product characteristics and cause failures and burnout.

- Corrosive gas or deoxidizing gas: chlorine gas, hydrogen sulfide gas, ammonia gas, sulfuric acid gas, nitric oxides gas, etc.
- Volatile or flammable gas
- Dusty conditions
- Low-pressure or high-pressure environments
- Wet or excessively humid locations
- Places with salt water, oils chemical liquids or organic solvents
- Where there are excessively strong vibrations
- Other places where similar hazardous conditions exist

Use these products within the specified temperature range. Higher temperature may cause deterioration of the characteristics or the material quality.

## Industrial Grade Sensors | Type 1, 2, 4, 4X, 12 and 13 NEMA Rated Enclosure

ICARE's Industrial sensors are enclosed in reliable, weatherproof NEMA-rated enclosures. Our NEMA-rated enclosures are constructed for both indoor or outdoor use and protect the sensor circuitry against the ingress of solid foreign objects like dust as well as the damaging effects of water (rain, sleet, snow, splashing water, and hose-directed water).

- Safe from falling dirt
- Protects against wind-blown dust
- Protects against rain, sleet, snow, splashing water, and hose-directed water
- Increased level of corrosion resistance
- Will remain undamaged by ice formation on the enclosure



For more information about our products or to place an order, please contact our sales department at 586-899-1150.

Visit us on the web at [www.icaremonitoring.com](http://www.icaremonitoring.com).

ICARE Monitoring  
Saint Clair Shores, MI 48082  
586-899-1150  
[www.icaremonitoring.com](http://www.icaremonitoring.com)